

*Registered / Registrato 19/01/2024*

*No 015047868-0003*



**EUROPEAN UNION INTELLECTUAL  
PROPERTY OFFICE  
CERTIFICATE OF REGISTRATION**

This Certificate of Registration is hereby issued for the Registered Community Design identified below. The corresponding entries have been recorded in the Register of Community Designs.

---

**UFFICIO DELL'UNIONE EUROPEA PER  
LA PROPRIETÀ INTELLETTUALE  
CERTIFICATO DI  
REGISTRAZIONE**

Il presente Certificato di Registrazione è emesso per il Disegno o Modello Comunitario registrato descritto di seguito. I dati corrispondenti sono stati iscritti nel Registro dei Disegni e Modelli Comunitari.

*The Executive Director / Il Direttore  
esecutivo*

*João Negrão*



[www.euipo.europa.eu](http://www.euipo.europa.eu)



21 015047868-0003  
25 EN - IT  
22 19/01/2024  
15 19/01/2024  
45 23/01/2024  
11 015047868-0003  
72 Shunping Liao  
73 FUJIAN BEST MANUFACTURING CO., LTD  
No. 109 Plant, Yongji Kengtou Village, Guangming Town,  
Jiangle County,  
Sanming, Fujian  
REPÚBLICA POPULAR DE CHINA  
74 METIDA  
Business center VERTAS Gyneju str. 16  
LT-01109 Vilnius  
LITUANIA  
51 22 - 06  
54 **BG** - Капани за мишки  
**ES** - Ratoneiras [trampas]  
**CS** - Pastičky na myši  
**DA** - Musefælder  
**DE** - Mäusefallen  
**ET** - Hiirelõksud  
**EL** - Ποντικοπαγίδες  
**EN** - Mousetraps  
**FR** - Souricières  
**IT** - Trappole per topi  
**LV** - Peļu slazdi  
**LT** - Pelių spąstai  
**HR** - Mišolovke  
**HU** - Egérfogók  
**MT** - Nases tal-ġrieden  
**NL** - Muizenvallen  
**PL** - Pułapki na myszy  
**PT** - Ratoeiras  
**RO** - Capcane pentru șoareci  
**SK** - Pasce na myši  
**SL** - Mišnice  
**FI** - Hiirenloukut  
**SV** - Musfällor  
30 -  
55 -

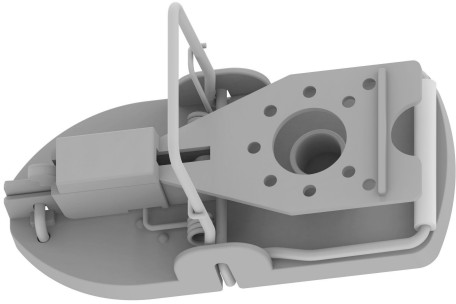

0003.1

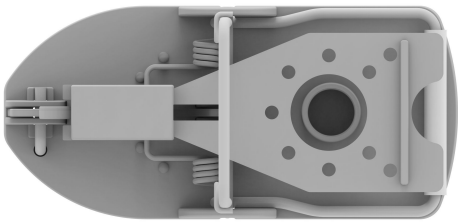

0003.2

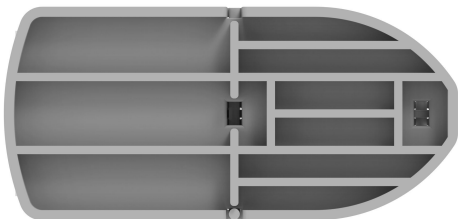

0003.3

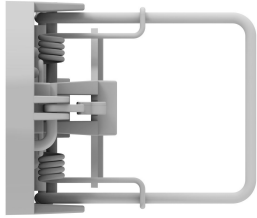

0003.4

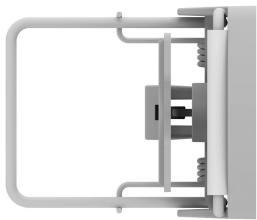

0003.5

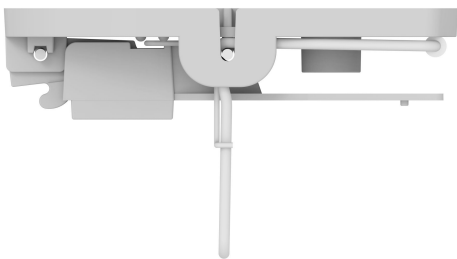

0003.6

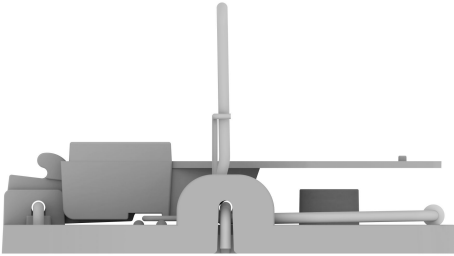

0003.7